

(mm)

PRODUCT INFORMATION

This product is an energy automatic sensor switch, it can identify day and night. It adopts infrared detector, IC and SMD technology, when someone enter its detecting range and triggered it work, the infrared detector turn on the lamp, after he leave its range, the lamp will turn off automatically. It can detect the ambient light illumination automatically and set and adjust the value according to the fact need. Such as, the light will turn on and works when the ambient light illumination is under setting value. once it exceeds the setting value, the light will stop working. It can be installed in indoor, corridor and public-building.

SPECIFICATIONS

Input: 12±1V DC

Output: max.12V DC , 2.5A / 30W

Light control:<10~2000LUX (adjustable)

Time-setting: 5s、 30s、 1Min、 3 Min、

5 Min、 8 Min.(adjustable)

Detecting range:8m (22°C) (adjustable)

Detecting angle:100°

Working temperature:-10~+40°C

working humidity: ≤93%RH

NAME OF EACH PART

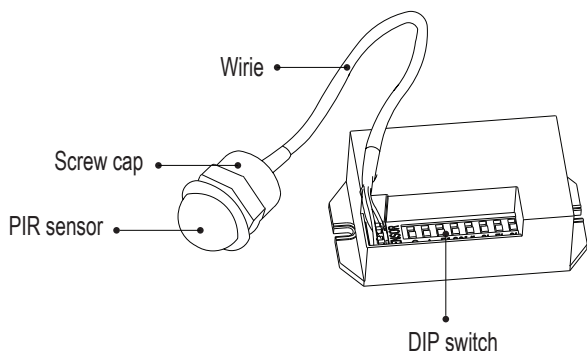

The nuts design at the head of the sensor makes it more convenient to fix on the installation object. There is also wiring for fixing made of plastic at its bottom in order to add its strength when being installed.

SENSOR INFORMATION

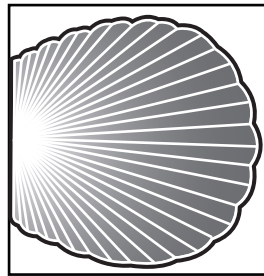
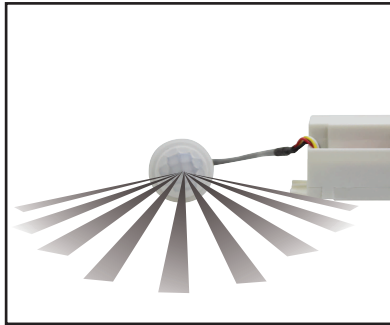

8m (22°C)
Correct moving orientation

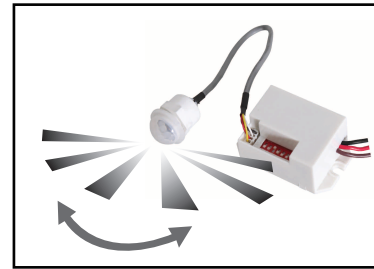

100°(22°C)
Induction Angle

FUNCTION

- Adopts 8-bit DIP switch:
 - You can select working light to work only in the light below 10lux or in any light;
 - Adjustable sensitivity;
 - Choose working time-delay of the load: 5s, 30s, 1Min, 3Min, 5Min, 8Min.
- The time that the load work can delay automatically: it re-computes time after the last sensing;
- Out connect infrared detector and sensitization resistor;
- Simple structure and using convenient.

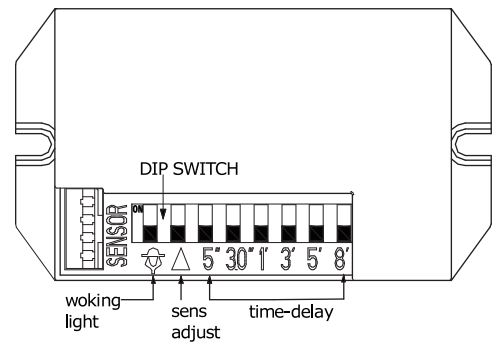

CONNECTION-WIRE FIGURE

Connect the wiring to the terminals according to the diagram.

Wire colours: x- red(+) y- black(-) z- brown(+)

Warning: do not short-circuit any terminals.

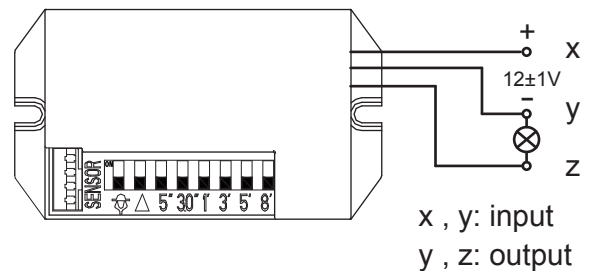

DIP SWITCH SETTING

- Working light(☼)selecting:
 - when no slide to ON, it can working in any light degree;
 - when slide to ON, it can only work at night(<10LUX).
- Sensitivity (▽) selecting:
 - when no slide to ON, High sensitivity;
 - when slide to ON, Low sensitivity.
- Time-delay (5", 30", 1', 3', 5', 8')
when select a certain time-delay, you only slide it to ON position.

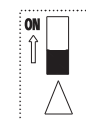
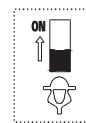

ATTENTION

When use this product, please adjust the sensitivity to an appropriate position you need, please do not adjust the sensitivity to maximum, to avoid the product does not work normally caused by wrong motion. Because the sensitivity is too high easily detect the wrong motion by wind blowing leaves & curtains, small animals, and the wrong motion by interference of power grid & electrical equipment. All those lead the product does not work normally !

When the product does not work normally, please try to lower the sensitivity appropriately, and then test it.

TEST

- Slide DIP 5"to ON position and other is on original position;
- Switch on power, after the load turn off, the sensor enter stable working state;
- Sense it once, the load turn on, and after 5s it turn off automatically;
- If slide DIP() to ON position, test it in the daytime, sense it, the load will not be on, cover the sensitization resistor with opaque object, sense it once again, the load will be on, and after 5s it turn off automaticall.

FOR OCCASIONS

It can be installed in indoor, corridor and public-building.

Installed inside on the device with non-metallic materials.

Eg, add the sensor, from one normal lighting to automatic sensor lamp.

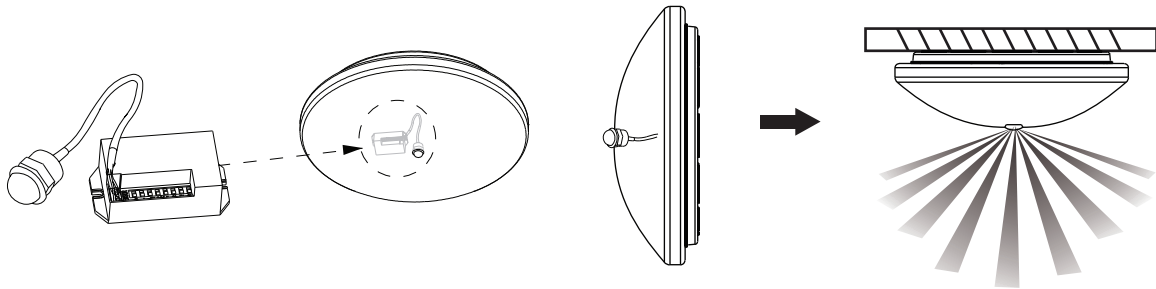

OPERATING PRINCIPLE OF THE LIGHT-CONTROL

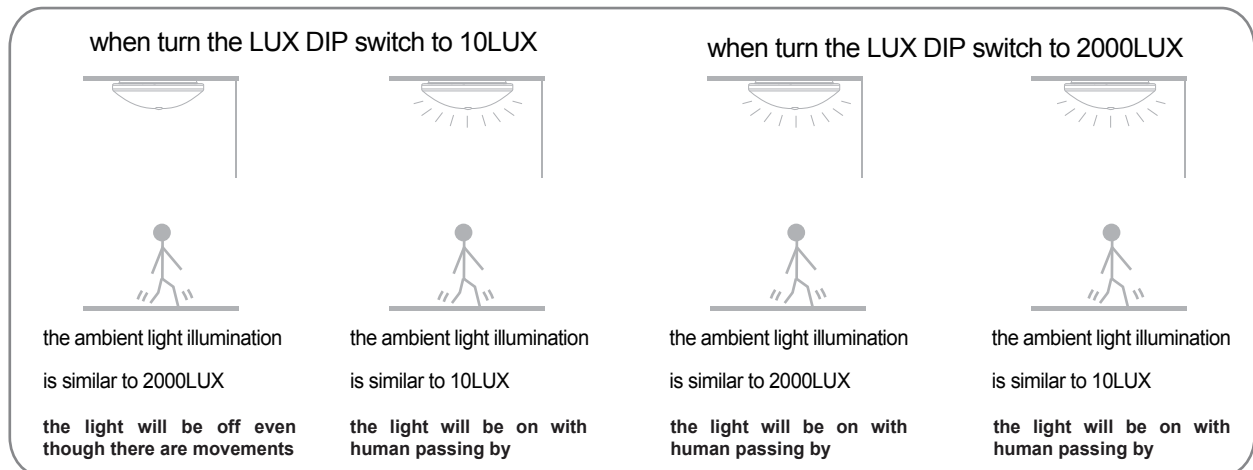

OPERATING PRINCIPLE OF TIME-SETTING

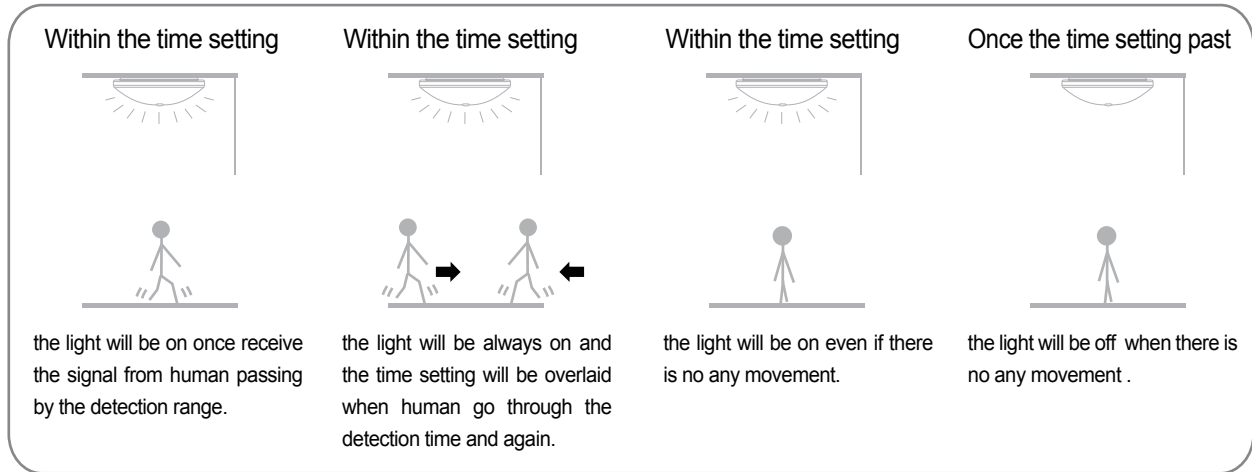

PAY ATTENTION TO INSTALLATION

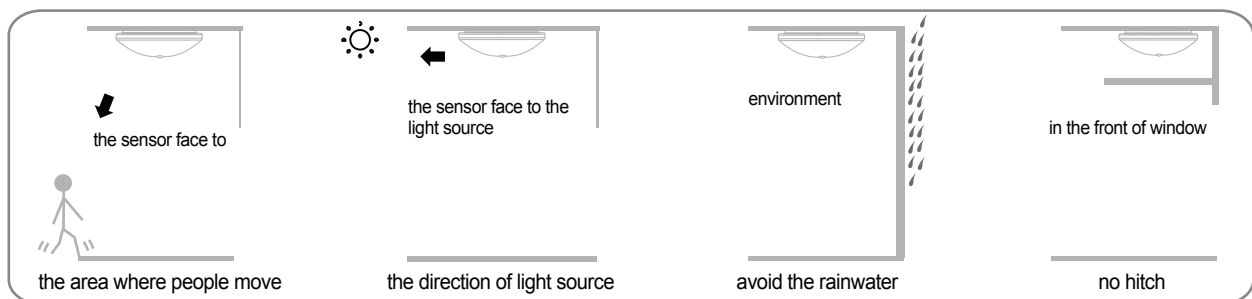
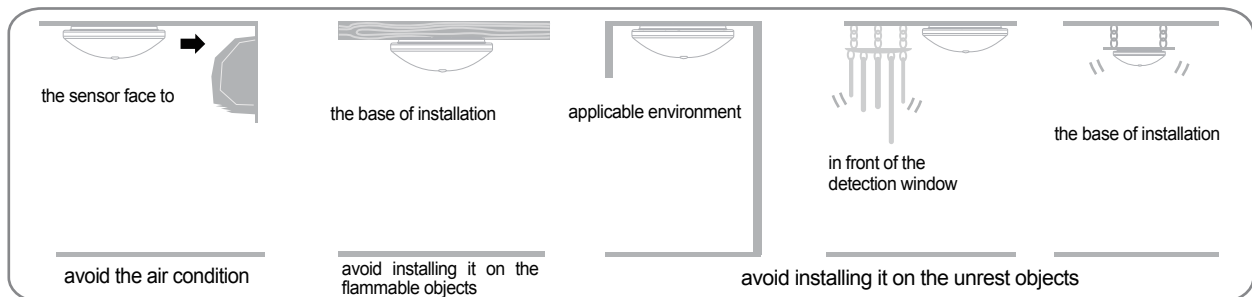

ATTENTION:

- The installing personnel should be electrician or with correlation experience;
- Be sure not to install the unit in the place where sun shine, current and temperature change obviously, for example air conditioning, air warm;
- Do not choose the sway object as installing base;
- In front of sense range there should be no obstruction or moving object to influent its detecting.

REMARK

1. Keep the sensor face to the area where human usually move.
2. Keep the sensor face to the position of the ambient light in order to get much more exact illuminance setting.
3. If detect the signal again within the time-delay, the time-delay will be over lied.

**Warning!**

- When used in different environments, please do not to adjust the sensitivity to the highest. Because that could easily lead to malfunction.
- Please confirm with professional installation.
- Please cut off power supply before installation and removal operations.
- Make sure that you have cut off the power for safety purposes.
- Improper operation caused losses, the manufacturer does not undertake any responsibility.

We are committed to promoting the product quality and reliability, however, all the electronic components have certain probabilities to become ineffective, which will cause some troubles. When designing, we have paid attention to redundant designs and adopted safety quota to avoid any troubles.

This instruction, without our permission, should not be copied for any other purposes.